

FCC TEST REPORT

Prepared for :

EDA Technology Shanghai Co.,Ltd

**Building 29, Shengchuang Enterprise Park, No.1661 Jialuo Road, Jiading
District, Shanghai, PRC**

Product Name: ED-MONITOR

Trade Mark: EDATEC

Product Model (S):

**ED-MONITOR-215CA,
ED-MONITOR-215C, ED-MONITOR-215,
ED-MONITOR-185CA,
ED-MONITOR-185C, ED-MONITOR-185,
ED-MONITOR-156CA,
ED-MONITOR-156C, ED-MONITOR-156,
ED-MONITOR-133CA,
ED-MONITOR-133C, ED-MONITOR-133,
ED-MONITOR-116CA,
ED-MONITOR-116C, ED-MONITOR-116**

Date of Test: Dec. 11, 2025 - Feb. 03, 2026

Date of Report: Feb. 03, 2026

Report Number: HK2512116493-1ER

Prepared By :

Shenzhen HUAK Testing Technology Co., Ltd.

**1-2/F., Building B2, Junfeng Zhongcheng Zhizao Innovation Park, Heping,
Fuhai Street, Bao'an District, Shenzhen, Guangdong, China**

The results shown in this test report refer only to the sample(s) tested unless otherwise stated and the sample(s) are retained for 15 days only. The document is issued by Shenzhen HUAK Testing Technology Co., Ltd., this document cannot be reproduced except in full with our prior written permission.

Shenzhen HUAK Testing Technology Co., Ltd. Tel.: +86-0755-2302 9901 E-mail: info@huak.com Web.: www.huak.com
Add.: 1-2/F., Building B2, Junfeng Zhongcheng Zhizao Innovation Park, Heping, Fuhai Street, Bao'an District, Shenzhen, Guangdong, China

TEST REPORT VERIFICATION

Applicant : EDA Technology Shanghai Co.,Ltd
Address : Building 29, Shengchuang Enterprise Park, No.1661 Jialuo Road, Jiading District, Shanghai, PRC
Manufacturer : EDA Technology Shanghai Co.,Ltd
Address : Building 29, Shengchuang Enterprise Park, No.1661 Jialuo Road, Jiading District, Shanghai, PRC
Product Name : ED-MONITOR
(A) Product Model : ED-MONITOR-215CA
ED-MONITOR-215C, ED-MONITOR-215, ED-MONITOR-185CA, ED-MONITOR-185C, ED-MONITOR-185, ED-MONITOR-156CA,
(B) Series Model : ED-MONITOR-156C, ED-MONITOR-156, ED-MONITOR-133CA, ED-MONITOR-133C, ED-MONITOR-133, ED-MONITOR-116CA, ED-MONITOR-116C, ED-MONITOR-116
(C) Power Supply : DC 12-24V From Adapter with AC 100-240V, 50/60Hz

Standards FCC Part 15 Subpart B
ANSI C63.4

This device described above has been tested by HUAKE, and the test results show that the equipment under test (EUT) is in compliance with Part 15 of FCC Rules. And it is applicable only to the tested sample identified in the report.

This report shall not be reproduced except in full, without the written approval of HUAKE, this document may be altered or revised by HUAKE, personal only, and shall be noted in the revision of the document.

Test Result **Pass**

Date of Test: _____ Dec. 11, 2025 - Feb. 03, 2026 _____

Prepared by: Kevin Pan
Project Engineer

Reviewed by: Silver Wong
Project Supervisor

Approved by: Jason Zhou
Technical Director

Table of Contents

	Page
1 . TEST SUMMARY	5
1.1 TEST FACILITY	6
1.2 MEASUREMENT UNCERTAINTY	6
2 . GENERAL INFORMATION	7
2.1 GENERAL DESCRIPTION OF EUT	7
2.2 DESCRIPTION OF TEST MODES	8
2.3 DESCRIPTION OF TEST SETUP	9
2.4 DESCRIPTION TEST PERIPHERAL AND EUT PERIPHERAL	10
2.5 MEASUREMENT INSTRUMENTS LIST	11
3 . EMC EMISSION TEST	12
3.1 CONDUCTED EMISSION MEASUREMENT	12
3.1.1 POWER LINE CONDUCTED EMISSION	12
3.1.2 TEST PROCEDURE	13
3.1.3 TEST SETUP	13
3.1.4 EUT OPERATING CONDITIONS	13
3.1.5 TEST RESULTS	14
3.2 RADIATED EMISSION MEASUREMENT	16
3.2.1 LIMITS OF RADIATED EMISSION MEASUREMENT	16
3.2.2 TEST PROCEDURE	16
3.2.3 TEST SETUP	17
3.2.4 EUT OPERATING CONDITIONS	17
3.2.5 TEST RESULTS(30~1000MHz)	18
3.2.6 TEST RESULTS(Above 1GHz)	20
4 . EUT TEST PHOTO	22
ATTACHMENT PHOTOGRAPHS OF EUT	23

**** Issued History ****

Revision	Description	Issued Date	Remark
Revision 1.0	Initial Test Report Release	2026/02/03	Jason Zhou

1. TEST SUMMARY

Test procedures according to the technical standards:

EMC Emission				
Standard	Test Item	Limit	Judgment	Remark
FCC Part 15 Subpart B ANSI C63.4	Conducted Emission	Class A	PASS	
	Radiated Emission	Class A	PASS	

NOTE:

- (1) 'N/A' denotes test is not applicable in this Test Report
- (2) For client's request and manual description, the test will not be executed.

Note: This equipment has been tested and found to comply with the limits for a Class A digital device, pursuant to part 15 of the FCC Rules. These limits are designed to provide reasonable protection against harmful interference when the equipment is operated in a commercial environment. This equipment generates, uses, and can radiate radio frequency energy and, if not installed and used in accordance with the instruction manual, may cause harmful interference to radio communications. Operation of this equipment in a residential area is likely to cause harmful interference in which case the user will be required to correct the interference at his own expense

1.1 TEST FACILITY

Shenzhen HUAK Testing Technology Co., Ltd.
 Add. : 1-2/F., Building B2, Junfeng Zhongcheng Zhizao Innovation Park, Heping, Fuhai Street,
 Bao'an District, Shenzhen, Guangdong, China

1.2 MEASUREMENT UNCERTAINTY

The reported uncertainty of measurement $y \pm U$ · where expanded uncertainty **U** is based on a standard uncertainty multiplied by a coverage factor of **k=2** · providing a level of confidence of approximately **95 %**.

A. Conducted Measurement :

Measurement Frequency Range	Uncertainty	NOTE
150kHz ~ 30MHz	±2.71dB	

B. Radiated Measurement :

Measurement Frequency Range	Uncertainty	NOTE
30 ~ 1000MHz	±3.90dB	
1 ~ 6GHz	±4.28dB	

2. GENERAL INFORMATION

2.1 GENERAL DESCRIPTION OF EUT

Product Name	ED-MONITOR					
Product Model	ED-MONITOR-215CA					
Series Model	ED-MONITOR-215C, ED-MONITOR-215, ED-MONITOR-185CA, ED-MONITOR-185C, ED-MONITOR-185, ED-MONITOR-156CA, ED-MONITOR-156C, ED-MONITOR-156, ED-MONITOR-133CA, ED-MONITOR-133C, ED-MONITOR-133, ED-MONITOR-116CA, ED-MONITOR-116C, ED-MONITOR-116					
Model Difference	All model's the function, software and electric circuit are the same, only with a product color and model named different. Test sample model: ED-MONITOR-215CA					
Product Description	<p>The EUT is a ED-MONITOR.</p> <table border="1"> <tr> <td>Operating frequency:</td> <td>N/A</td> </tr> <tr> <td>Connecting I/O port:</td> <td>N/A</td> </tr> </table>		Operating frequency:	N/A	Connecting I/O port:	N/A
Operating frequency:	N/A					
Connecting I/O port:	N/A					
Power Source	DC Voltage					
Power Rating	DC 12-24V From Adapter with AC 100-240V, 50/60Hz					

2.2 DESCRIPTION OF TEST MODES

To investigate the maximum EMI emission characteristics generates from EUT, the test system was pre-scanning tested base on the consideration of following EUT operation mode or test configuration mode which possible have effect on EMI emission level. Each of these EUT operation mode(s) or test configuration mode(s) mentioned above was evaluated respectively.

Pretest Mode	Description
Mode 1	Working

For Conducted Test	
Final Test Mode	Description
Mode 1	Working

For Radiated Test	
Final Test Mode	Description
Mode 1	Working

2.3 DESCRIPTION OF TEST SETUP

Mode 1:

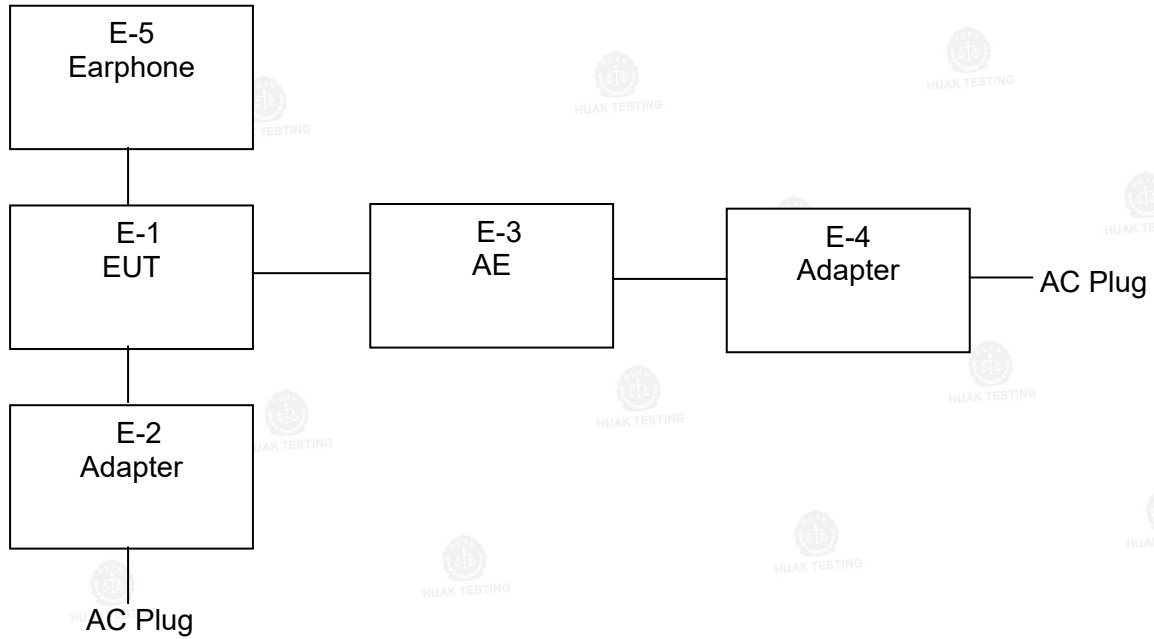

2.4 DESCRIPTION TEST PERIPHERAL AND EUT PERIPHERAL

The EUT has been tested as an independent unit together with other necessary accessories or support units. The following support units or accessories were used to form a representative test configuration during the tests.

Item	Equipment	Trade Mark	Model/Type No.	Series No.	Note
E-1	ED-MONITOR	EDATEC	ED-MONITOR-215CA	N/A	EUT
E-2	Adapter	N/A	KSASB0241200200D5	N/A	
E-3	AE	N/A	N/A	N/A	
E-4	Adapter	N/A	N/A	N/A	
E-5	Earphone	N/A	N/A	N/A	

Item	Shielded Type	Ferrite Core	Length	Note

Note:

- (1) The support equipment was authorized by Declaration of Confirmation.
- (2) For detachable type I/O cable should be specified the length in cm in 『Length』 column.
- (3) “YES” is means “shielded” “with core”; “NO” is means “unshielded” “without core”.

2.5 MEASUREMENT INSTRUMENTS LIST

Item	Equipment	Manufacturer	Model No.	Serial No.	Last Cal.	Cal. Interval
1.	L.I.S.N.	R&S	ENV216	HKE-002	Feb. 19, 2025	1 Year
2.	L.I.S.N.	R&S	ENV216	HKE-059	Feb. 19, 2025	1 Year
3.	EMI Test Receiver	R&S	ESR-7	HKE-005	Feb. 19, 2025	1 Year
4.	Spectrum analyzer	Agilent	N9020A	HKE-048	Feb. 19, 2025	1 Year
5.	Spectrum analyzer	R&S	FSV3044	HKE-126	Feb. 19, 2025	1 Year
6.	Preamplifier	Schwarzbeck	EMC05184 5S	HKE-006	Feb. 19, 2025	1 Year
7.	Preamplifier	Schwarzbeck	BBV 9743	HKE-016	Feb. 19, 2025	1 Year
8.	Preamplifier	A.H. Systems	SAS-574	HKE-182	Feb. 19, 2025	1 Year
9.	6d Attenuator	Pasternack	6db	HKE-184	Feb. 19, 2025	1 Year
10.	EMI Test Receiver	R&S	ESR-7	HKE-010	Feb. 19, 2025	1 Year
11.	Broadband Antenna	Schwarzbeck	VULB9168	HKE-167	Feb. 21, 2024	2 Year
12.	Loop Antenna	COM-POWER	AL-130R	HKE-014	Feb. 21, 2024	2 Year
13.	Horn Antenna	Schwarzbeck	9120D	HKE-013	Feb. 21, 2024	2 Year
14.	EMI Test Software	Tonscend	JS32-CE 2.5.0.6	HKE-081	/	/
15.	EMI Test Software	Tonscend	JS32-RE 5.0.0	HKE-082	/	/

3. EMC EMISSION TEST

3.1 CONDUCTED EMISSION MEASUREMENT

3.1.1 POWER LINE CONDUCTED EMISSION (Frequency Range 150kHz~30MHz)

FREQUENCY (MHz)	Class A (dBuV)		Class B (dBuV)	
	Quasi-peak	Average	Quasi-peak	Average
0.15 ~ 0.5	79.00	66.00	66 ~ 56 *	56 ~ 46 *
0.50 ~ 5.0	73.00	60.00	56.00	46.00
5.0 ~ 30.0	73.00	60.00	60.00	50.00

Note:

(1) The tighter limit applies at the band edges.

(2) The limit of " * " marked band means the limitation decreases linearly with the logarithm of the frequency in the range.

The following table is the setting of the receiver

Receiver Parameters	Setting
Attenuation	10 dB
Start Frequency	0.15 MHz
Stop Frequency	30 MHz
IF Bandwidth	9 kHz

3.1.2 TEST PROCEDURE

- a. The EUT was placed 0.8 meters from the horizontal ground plane with EUT being connected to the power mains through a line impedance stabilization network (LISN). All other support equipments powered from additional LISN(s). The LISN provide 50 Ohm/ 50uH of coupling impedance for the measuring instrument.
- b. Interconnecting cables that hang closer than 40 cm to the ground plane shall be folded back and forth in the center forming a bundle 30 to 40 cm long.
- c. I/O cables that are not connected to a peripheral shall be bundled in the center. The end of the cable may be terminated, if required, using the correct terminating impedance. The overall length shall not exceed 1 m.
- d. LISN at least 80 cm from nearest part of EUT chassis.
- e. For the actual test configuration, please refer to the related Item –EUT Test Photos.

3.1.3 TEST SETUP

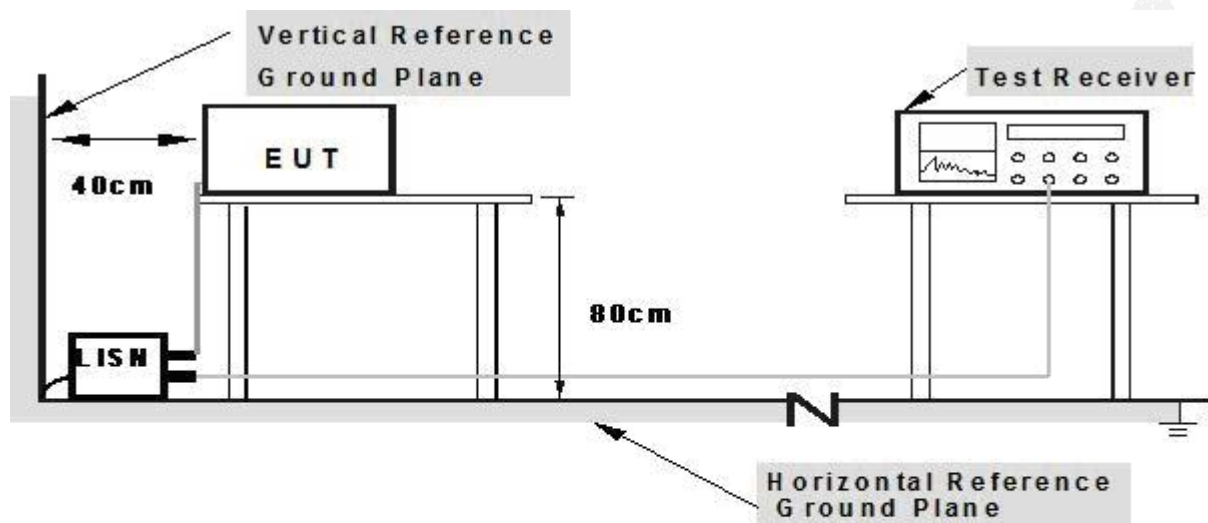

- Note: 1. Support units were connected to second LISN.**
2. Both of LISN's (AMN) are 80 cm from EUT and at least 80 cm from other units and other metal planes

3.1.4 EUT OPERATING CONDITIONS

The EUT tested system was configured as the statements of 2.3 Unless otherwise a special operating condition is specified in the follows during the testing.

3.1.5 TEST RESULTS

EUT :	ED-MONITOR	Model Name. :	ED-MONITOR-215CA
Temperature :	23.7 °C	Relative Humidity :	51%
Pressure :	1010 hPa	Test Date :	2026-01-23
Test Mode :	Mode 1	Polarization :	L
Test Voltage :	DC 12V From Adapter		

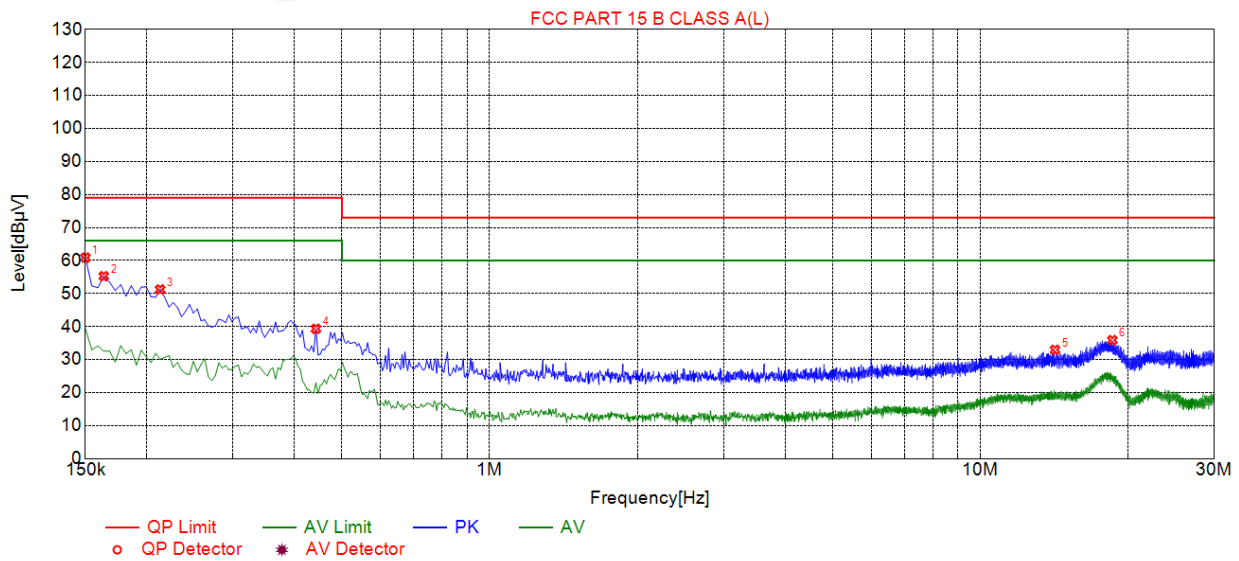

Suspected List								
NO.	Freq. [MHz]	Level [dBµV]	Factor [dB]	Limit [dBµV]	Margin [dB]	Reading [dBµV]	Detector	Type
1	0.1500	60.88	19.53	79.00	18.12	41.35	PK	L
2	0.1635	55.24	19.56	79.00	23.76	35.68	PK	L
3	0.2130	51.23	19.85	79.00	27.77	31.38	PK	L
4	0.4425	39.32	19.85	79.00	39.68	19.47	PK	L
5	14.2035	32.94	21.73	73.00	40.06	11.21	PK	L
6	18.5910	35.87	22.67	73.00	37.13	13.20	PK	L

Remark: Margin = Limit – Level

Correction factor = Cable lose + LISN insertion loss

Level=Test receiver reading + correction factor

EUT :	ED-MONITOR	Model Name. :	ED-MONITOR-215CA
Temperature :	23.7 °C	Relative Humidity :	51%
Pressure :	1010 hPa	Test Date :	2026-01-23
Test Mode :	Mode 1	Polarization :	N
Test Voltage :	DC 12V From Adapter		

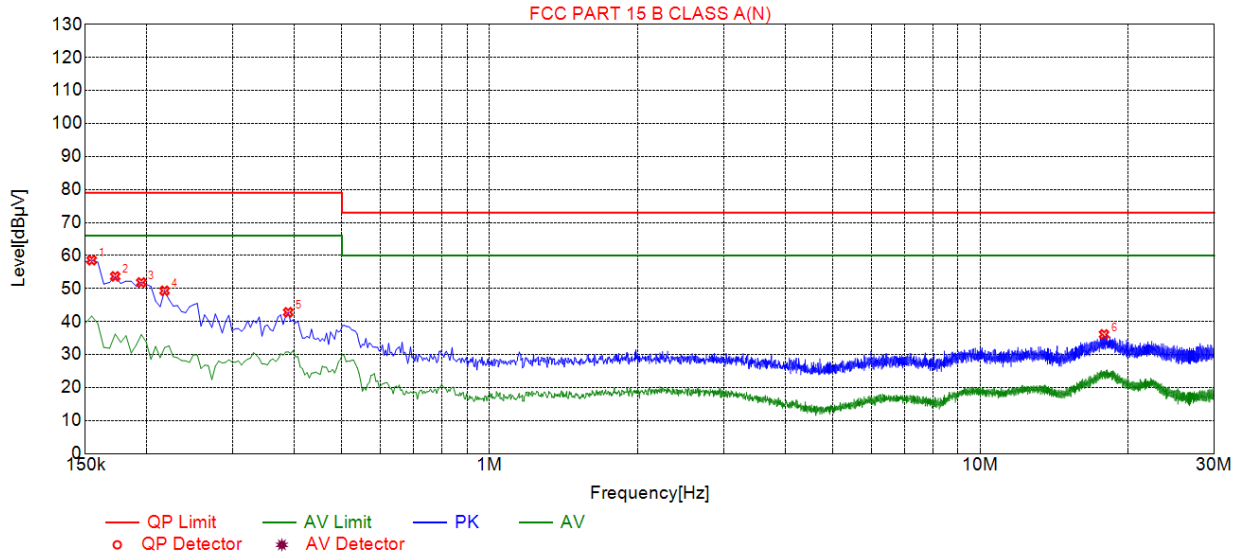

Suspected List								
NO.	Freq. [MHz]	Level [dBµV]	Factor [dB]	Limit [dBµV]	Margin [dB]	Reading [dBµV]	Detector	Type
1	0.1545	58.58	19.63	79.00	20.42	38.95	PK	N
2	0.1725	53.69	19.64	79.00	25.31	34.05	PK	N
3	0.1950	51.84	19.63	79.00	27.16	32.21	PK	N
4	0.2175	49.33	19.66	79.00	29.67	29.67	PK	N
5	0.3885	42.81	19.70	79.00	36.19	23.11	PK	N
6	17.8845	36.11	22.52	73.00	36.89	13.59	PK	N

Remark: Margin = Limit – Level

Correction factor = Cable lose + LISN insertion loss

Level=Test receiver reading + correction factor

3.2 RADIATED EMISSION MEASUREMENT

3.2.1 LIMITS OF RADIATED EMISSION MEASUREMENT

FREQUENCY (MHz)	Class A (at 10m)	Class B (at 3m)
	dBuV/m	dBuV/m
30 ~ 88	39.0	40.0
88 ~ 216	43.5	43.5
216 ~ 960	46.5	46.0
Above 960	49.5	54.0

Notes:

- (1) The tighter limit applies at the band edges.

3.2.2 TEST PROCEDURE

- a. The measured distance is 3m.
- b. The EUT was placed on the top of a rotating table 0.8 meters above the ground at a 3 meter open area test site. The table was rotated 360 degrees to determine the position of the highest radiation.
- c. The height of the equipment or of the substitution antenna shall be 0.8 m; the height of the test antenna shall vary between 1 m to 4 m. Both horizontal and vertical polarizations of the antenna are set to make the measurement.
- d. The initial step in collecting conducted emission data is a spectrum analyzer peak detector mode pre-scanning the measurement frequency range. Significant peaks are then marked and then Quasi Peak detector mode re-measured, above 1G Average detector mode will be instead.
- e. If the Peak Mode measured value compliance with and lower than Quasi Peak Mode Limit, the EUT shall be deemed to meet QP(AV) Limits and then no additional QP Mode measurement performed.
- f. For the actual test configuration, please refer to the related Item –EUT Test Photos.

3.2.3 TEST SETUP

(A) Radiated Emission Test Set-Up Frequency Below 1 GHz

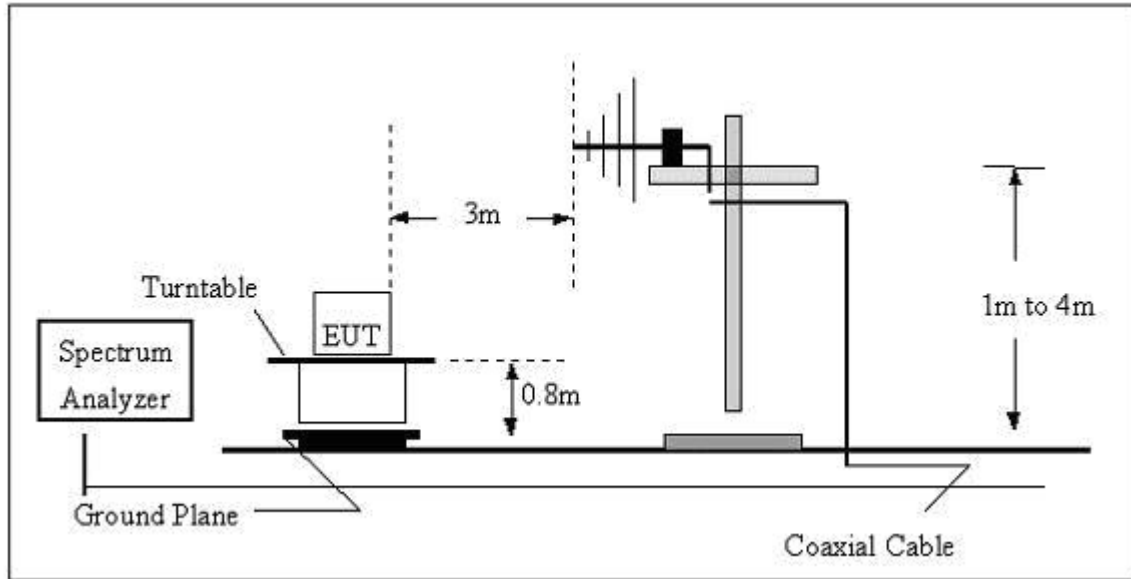

(B) Radiated Emission Test Set-Up Frequency Above 1GHz

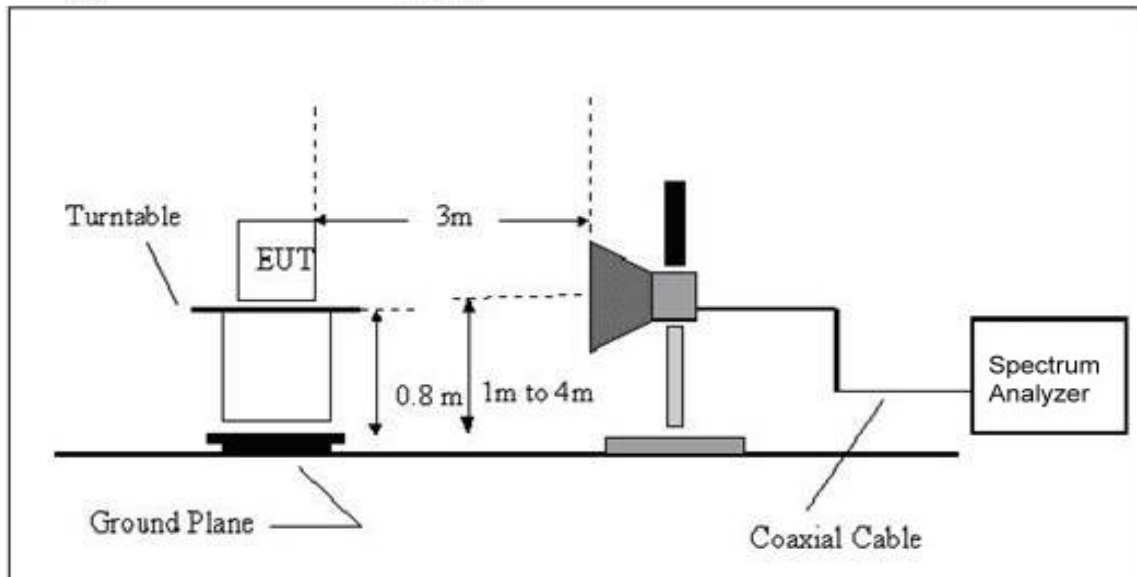

3.2.4 EUT OPERATING CONDITIONS

The EUT tested system was configured as the statements of 2.3 Unless otherwise a special operating condition is specified in the follows during the testing.

3.2.5 TEST RESULTS(30~1000MHz)

EUT :	ED-MONITOR	Model Name :	ED-MONITOR-215CA
Temperature :	23.7 °C	Relative Humidity :	51%
Pressure :	1010 hPa	Test Date :	2026-01-23
Test Mode :	Mode 1	Polarization :	Horizontal
Test Power :	DC 12V From Adapter		

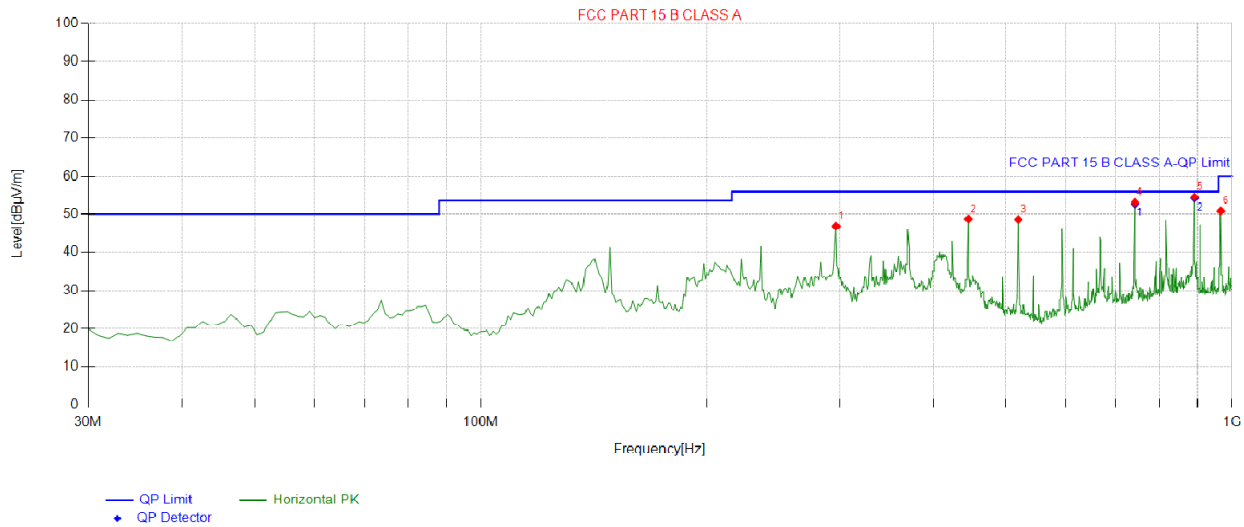

Suspected List									
NO.	Freq. [MHz]	Factor [dB]	Reading [dBµV/m]	Level [dBµV/m]	Limit [dBµV/m]	Margin [dB]	Height [cm]	Angle [°]	Polarity
1	297.01701	-11.39	58.28	46.89	56.00	9.11	100	227	Horizontal
2	445.57557	-7.88	56.62	48.74	56.00	7.26	100	214	Horizontal
3	519.36936	-6.64	55.23	48.59	56.00	7.41	100	296	Horizontal
4	742.69269	-2.37	55.45	53.08	56.00	2.92	100	164	Horizontal
5	891.25125	-0.39	54.97	54.58	56.00	1.42	100	301	Horizontal
6	966.01601	0.45	50.43	50.88	60.00	9.12	100	116	Horizontal

Final Data List									
NO.	Freq. [MHz]	Factor [dB]	QP Reading [dBµV/m]	QP Value [dBµV/m]	QP Limit [dBµV/m]	QP Margin [dB]	Height [cm]	Angle [°]	Polarity
1	742.69269	-2.37	55.05	52.68	56.00	3.32	100	164	Horizontal
2	891.25125	-0.39	54.57	54.18	56.00	1.82	100	301	Horizontal

Final Data List

Remark: Factor = Cable loss + Antenna factor – Preamplifier; Level = Reading + Factor; Margin = Limit – Level;

The results shown in this test report refer only to the sample(s) tested unless otherwise stated and the sample(s) are retained for 15 days only. The document is issued by Shenzhen HUAKE Testing Technology Co., Ltd., this document cannot be reproduced except in full with our prior written permission.

EUT :	ED-MONITOR	Model Name :	ED-MONITOR-215CA
Temperature :	23.7 °C	Relative Humidity :	51%
Pressure :	1010 hPa	Test Date :	2026-01-23
Test Mode :	Mode 1	Polarization :	Vertical
Test Power :	DC 12V From Adapter		

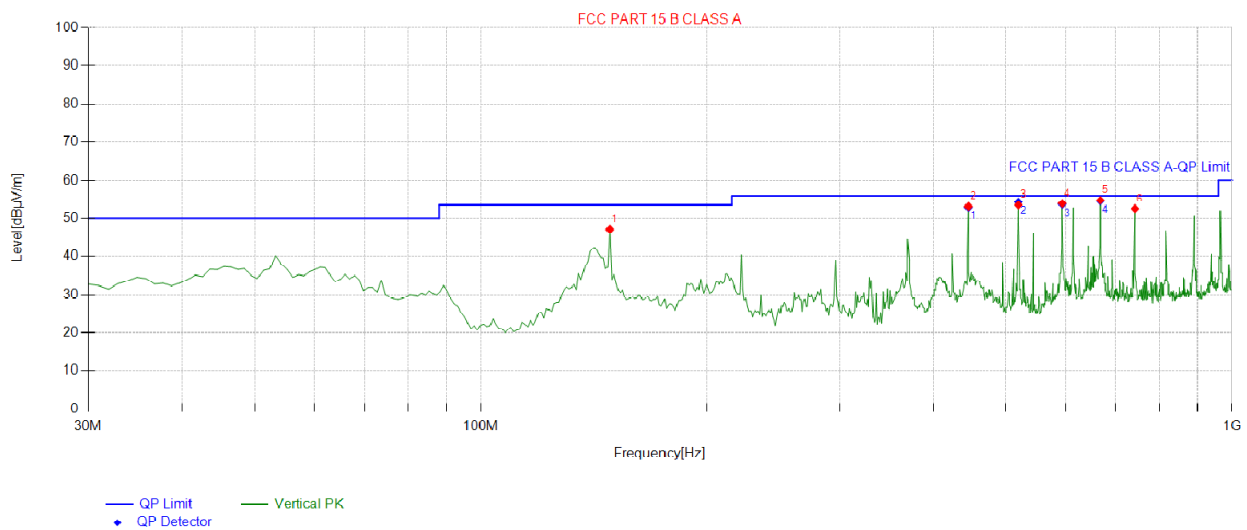

Suspected List									
NO.	Freq. [MHz]	Factor [dB]	Reading [dBµV/m]	Level [dBµV/m]	Limit [dBµV/m]	Margin [dB]	Height [cm]	Angle [°]	Polarity
1	148.45845	-11.21	58.35	47.14	53.50	6.36	100	194	Vertical
2	445.57557	-7.88	60.99	53.11	56.00	2.89	100	162	Vertical
3	519.36936	-6.64	60.14	53.50	56.00	2.50	100	218	Vertical
4	594.13413	-5.34	59.26	53.92	56.00	2.08	100	12	Vertical
5	667.92792	-3.56	58.31	54.75	56.00	1.25	100	228	Vertical
6	742.69269	-2.37	54.91	52.54	56.00	3.46	100	348	Vertical

Final Data List									
NO.	Freq. [MHz]	Factor [dB]	QP Reading [dBµV/m]	QP Value [dBµV/m]	QP Limit [dBµV/m]	QP Margin [dB]	Height [cm]	Angle [°]	Polarity
1	445.57557	-7.88	60.77	52.89	56.00	3.11	100	162	Vertical
2	519.36936	-6.64	60.92	54.28	56.00	1.72	100	218	Vertical
3	594.13413	-5.34	59.04	53.70	56.00	2.30	100	12	Vertical
4	667.92792	-3.56	58.09	54.53	56.00	1.47	100	228	Vertical

Final Data List

Remark: Factor = Cable loss + Antenna factor – Pre-amplifier; Level = Reading + Factor; Margin = Limit – Level;

The results shown in this test report refer only to the sample(s) tested unless otherwise stated and the sample(s) are retained for 15 days only. The document is issued by Shenzhen HUAK Testing Technology Co., Ltd., this document cannot be reproduced except in full with our prior written permission.

3.2.6 TEST RESULTS(Above 1GHz)

EUT :	ED-MONITOR	Model Name :	ED-MONITOR-215CA
Temperature :	23.7 °C	Relative Humidity :	51%
Pressure :	1010 hPa	Test Date :	2026-01-23
Test Mode :	Mode 1	Polarization :	Horizontal
Test Power :	DC 12V From Adapter		

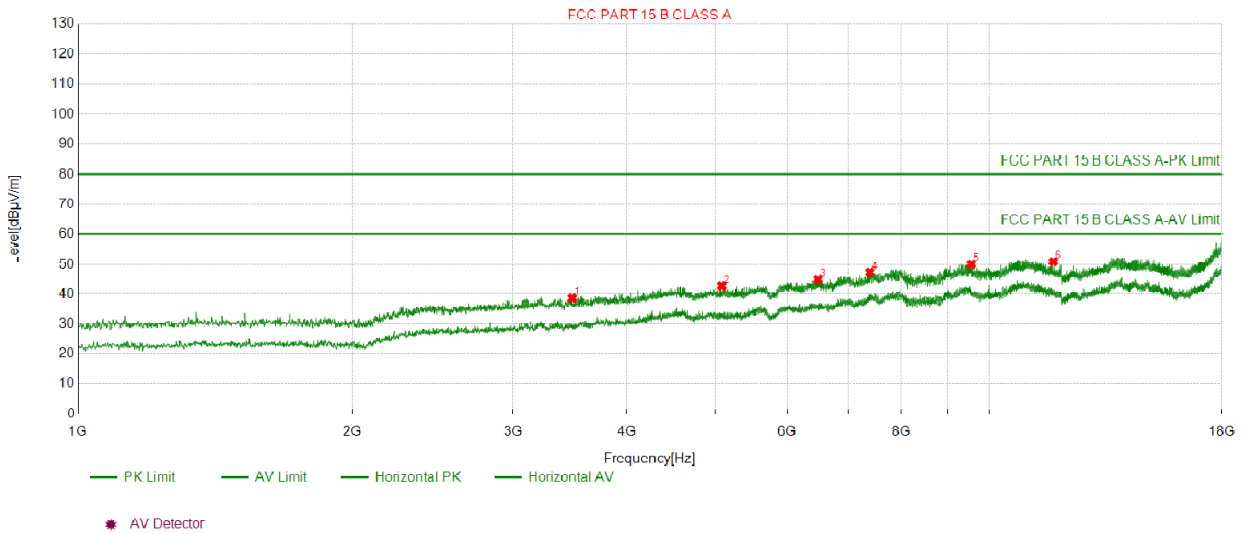

Suspected Data List									
NO.	Freq. [MHz]	Reading [dBµV/m]	PK Level [dBµV/m]	Factor [dB]	PK Limit [dBµV/m]	PK Margin [dB]	Height [cm]	Angle [°]	Polarity
1	3485.648	52.75	38.60	-14.15	80.00	41.40	100	200	Horizontal
2	5083.808	52.10	42.75	-9.35	80.00	37.25	100	360	Horizontal
3	6486.448	51.78	44.92	-6.86	80.00	35.08	100	170	Horizontal
4	7392.639	51.35	47.36	-3.99	80.00	32.64	100	130	Horizontal
5	9553.555	50.59	50.07	-0.52	80.00	29.93	100	170	Horizontal
6	11750.17	49.76	50.89	1.13	80.00	29.11	100	120	Horizontal

Remark: Factor = Cable loss + Antenna factor – Preamplifier; Level = Reading + Factor; Margin = Limit – Level;

EUT :	ED-MONITOR	Model Name :	ED-MONITOR-215CA
Temperature :	23.7 °C	Relative Humidity :	51%
Pressure :	1010 hPa	Test Date :	2026-01-23
Test Mode :	Mode 1	Polarization :	Vertical
Test Power :	DC 12V From Adapter		

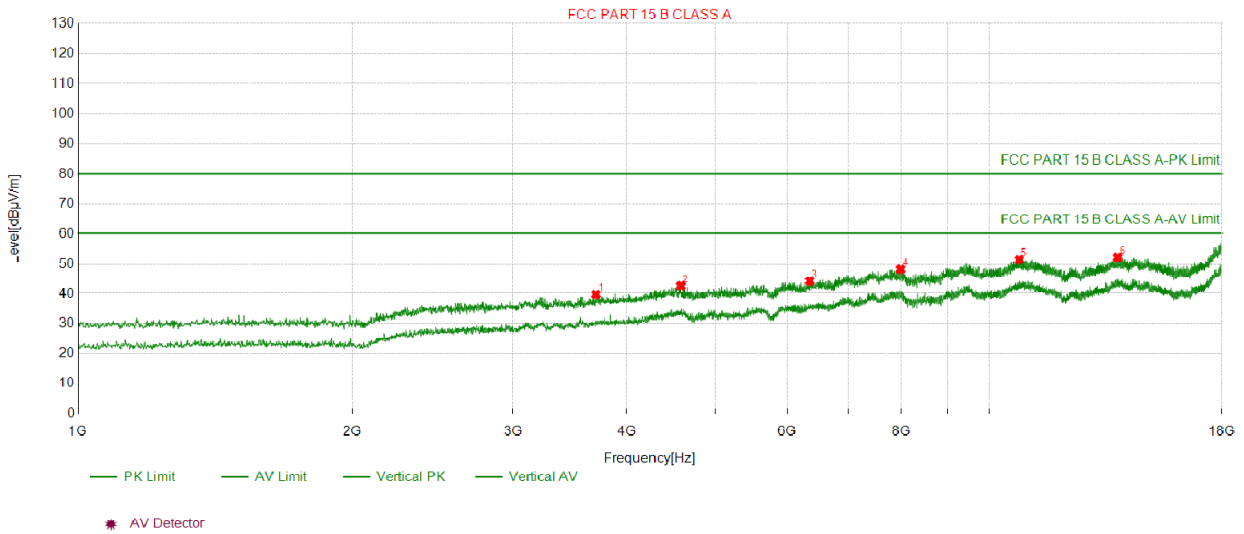

Suspected Data List									
NO.	Freq. [MHz]	Reading [dBµV/m]	PK Level [dBµV/m]	Factor [dB]	PK Limit [dBµV/m]	PK Margin [dB]	Height [cm]	Angle [°]	Polarity
1	3699.870	52.30	39.75	-12.55	80.00	40.25	100	270	Vertical
2	4587.358	52.18	42.64	-9.54	80.00	37.36	100	10	Vertical
3	6350.435	51.55	44.25	-7.30	80.00	35.75	100	150	Vertical
4	7992.799	50.36	48.24	-2.12	80.00	31.76	100	40	Vertical
5	10779.37	50.42	51.50	1.08	80.00	28.50	100	330	Vertical
6	13826.08	47.02	52.27	5.25	80.00	27.73	100	330	Vertical

Remark: Factor = Cable loss + Antenna factor – Preamplifier; Level = Reading + Factor; Margin = Limit – Level;

4. EUT TEST PHOTO

Conducted Emission

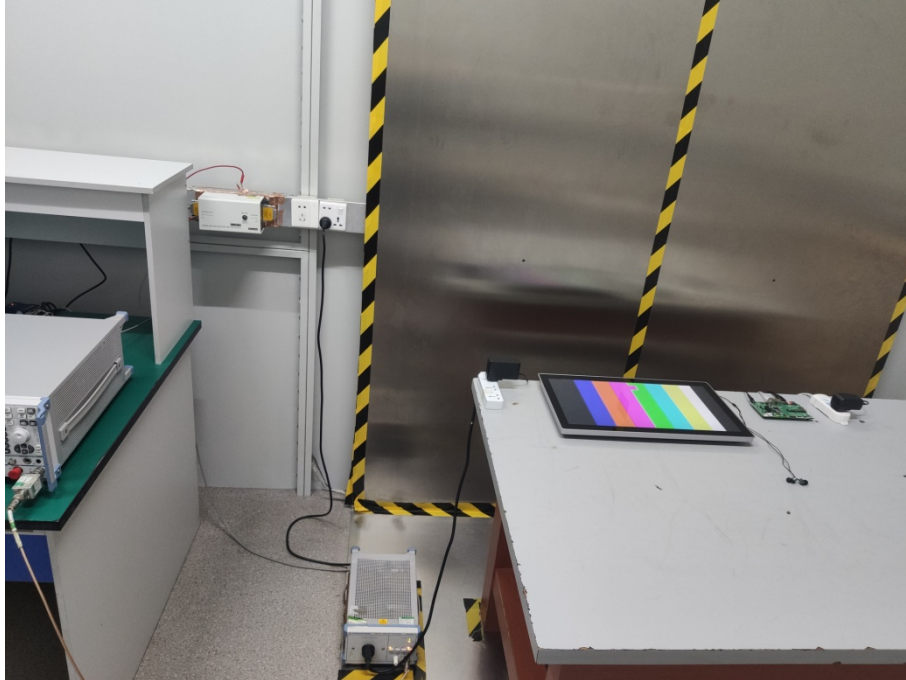

Radiated Emission

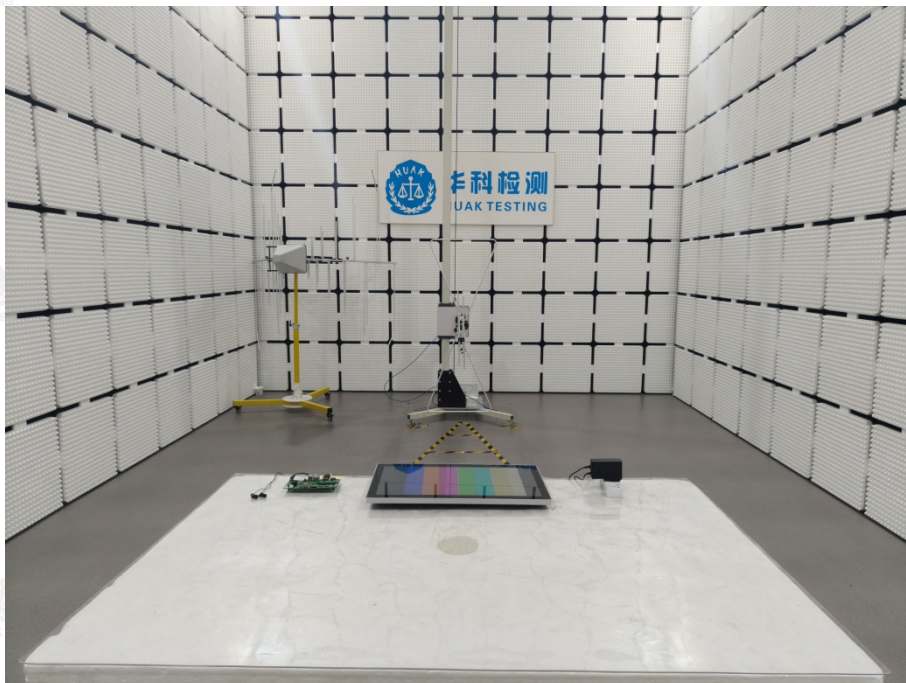

The results shown in this test report refer only to the sample(s) tested unless otherwise stated and the sample(s) are retained for 15 days only. The document is issued by Shenzhen HUAK Testing Technology Co., Ltd., this document cannot be reproduced except in full with our prior written permission.

ATTACHMENT PHOTOGRAPHS OF EUT

Photo 1



Photo 2



Photo 3



Photo 4



The results shown in this test report refer only to the sample(s) tested unless otherwise stated and the sample(s) are retained for 15 days only. The document is issued by Shenzhen HUAKE Testing Technology Co., Ltd., this document cannot be reproduced except in full with our prior written permission.

Photo 5



Photo 6



Photo 7

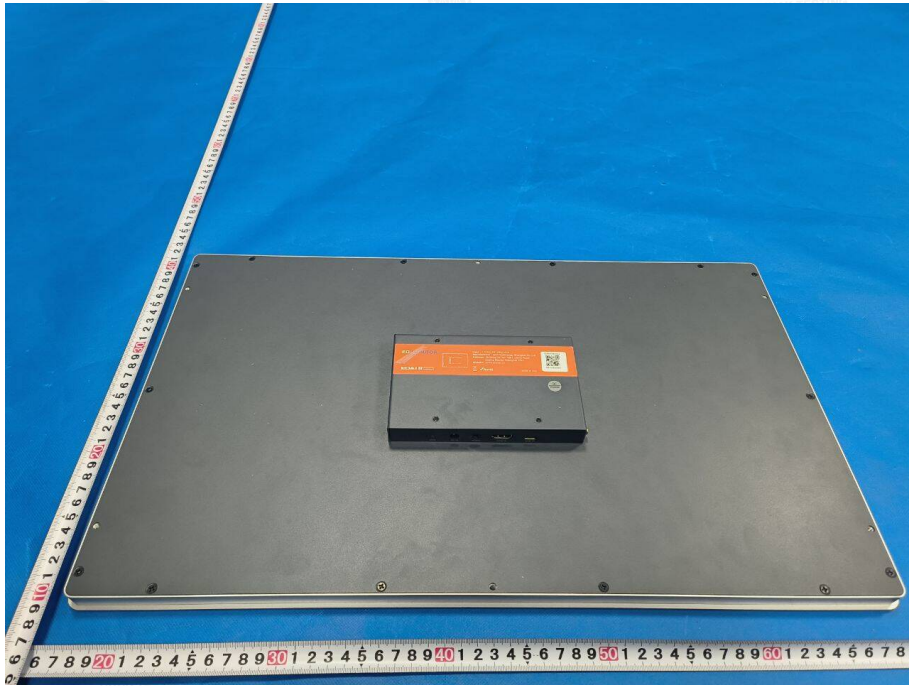

Photo 8

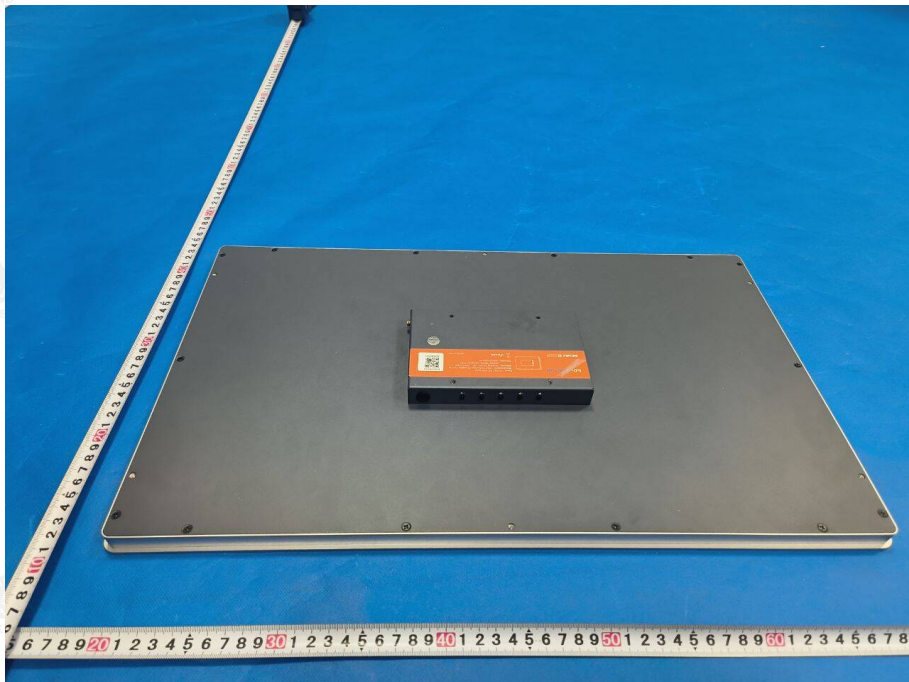

Photo 9

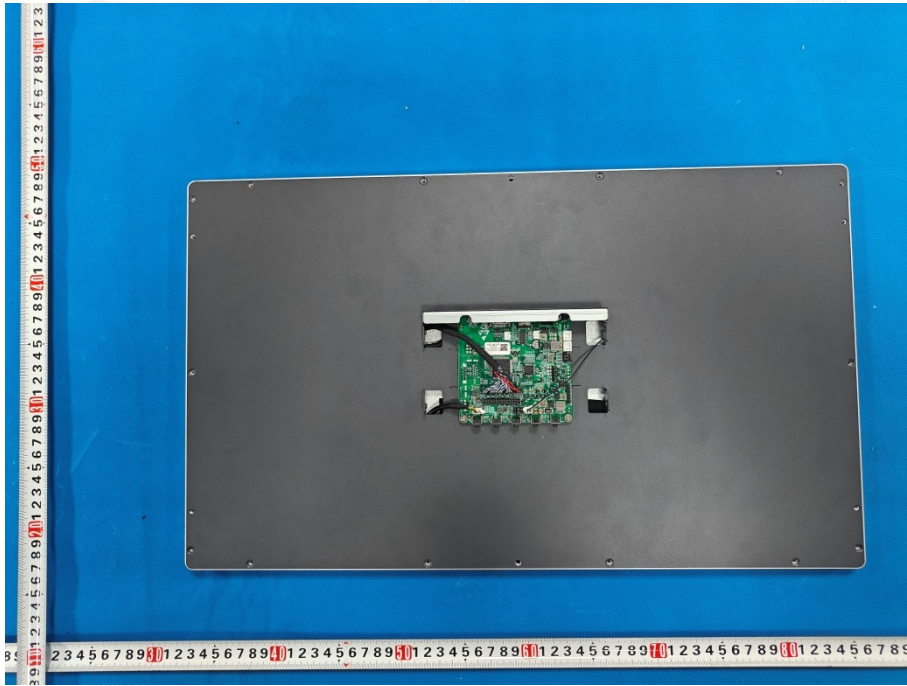

Photo 10

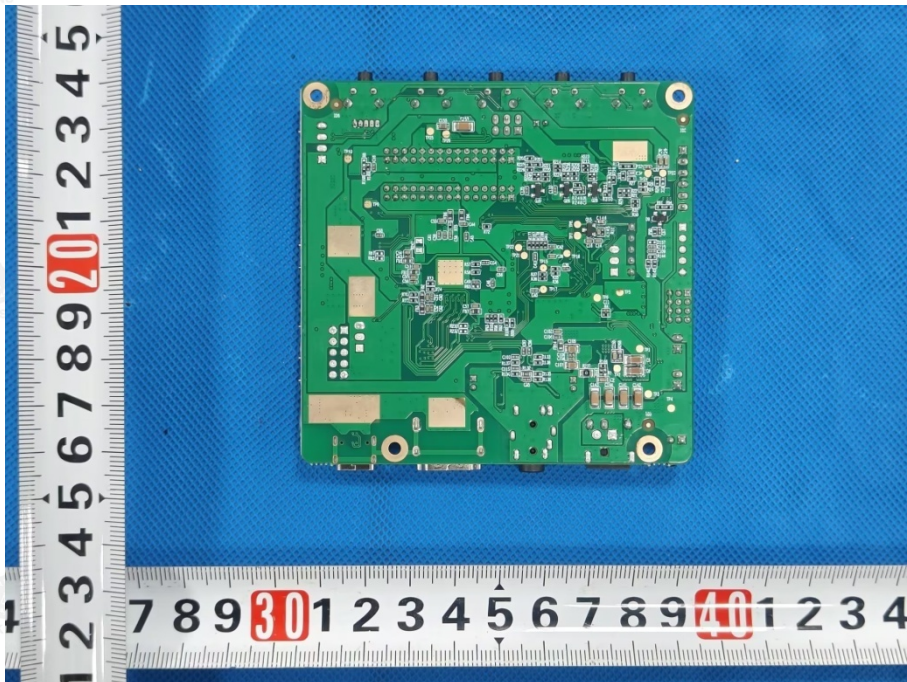

Photo 11

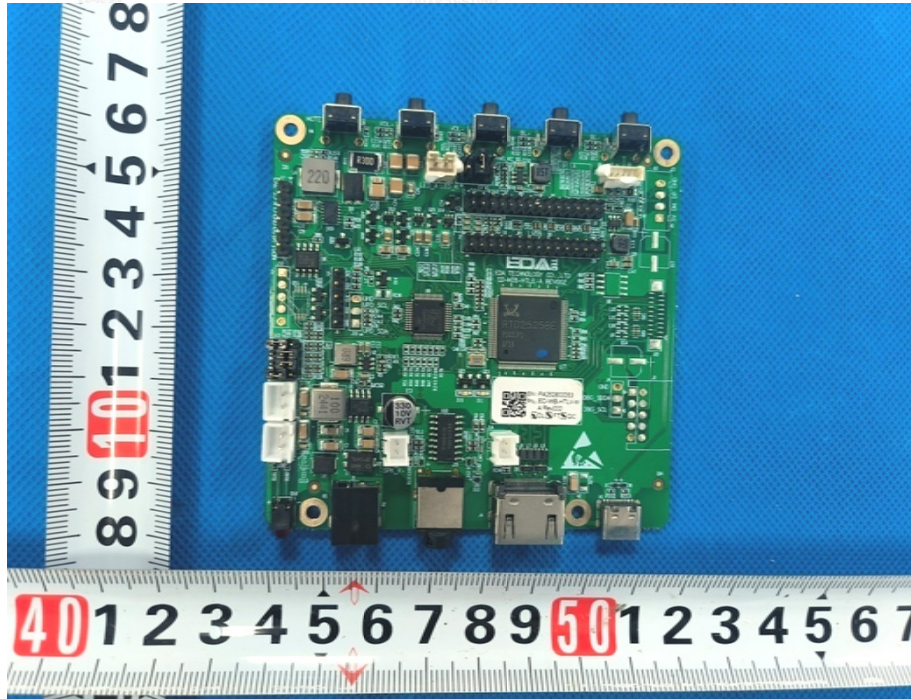

Photo 12



Photo 13

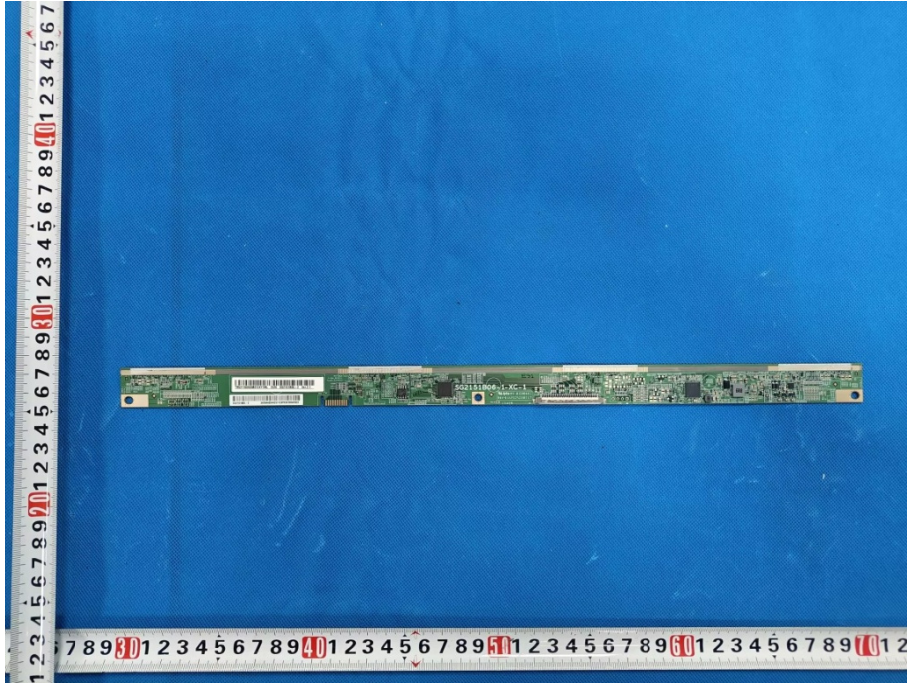
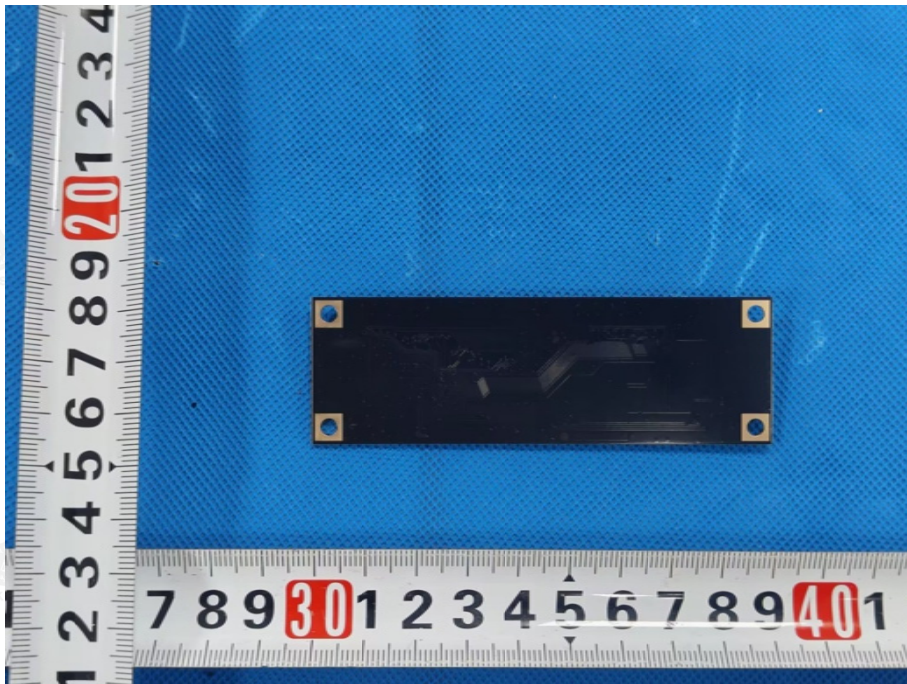
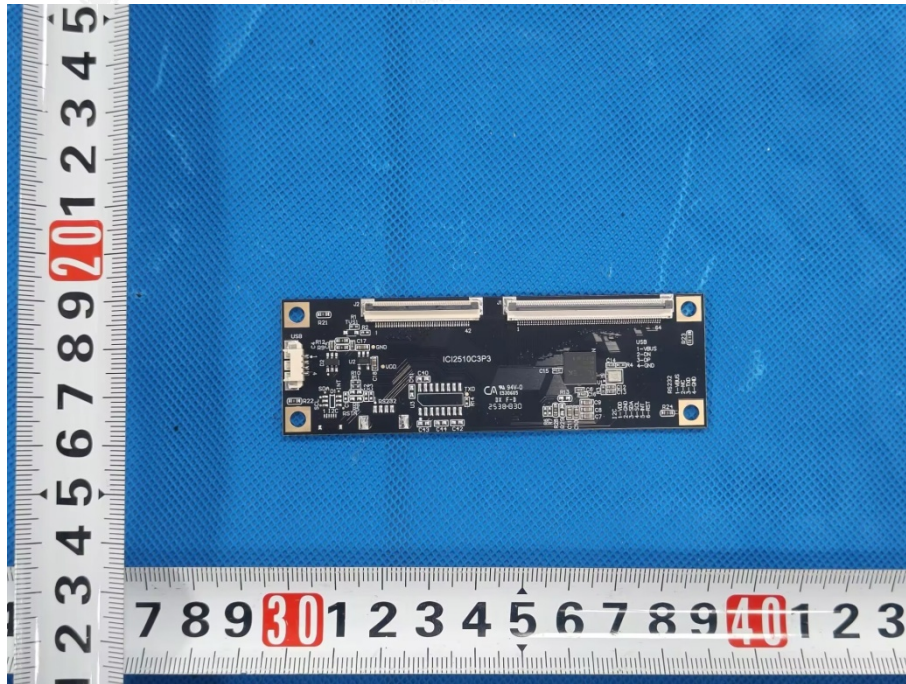

Photo 14



The results shown in this test report refer only to the sample(s) tested unless otherwise stated and the sample(s) are retained for 15 days only. The document is issued by Shenzhen HUAKE Testing Technology Co., Ltd., this document cannot be reproduced except in full with our prior written permission.

Photo 15



-----End of report-----